













### Symbols

-  Pressure Relief Valve
-  Balance Valve
-  Ball Valve
-  Check Valve
-  Union
-  Air Vent
-  Pump
-  Strainer
-  Flexible Fitting
-  Expansion Vessel

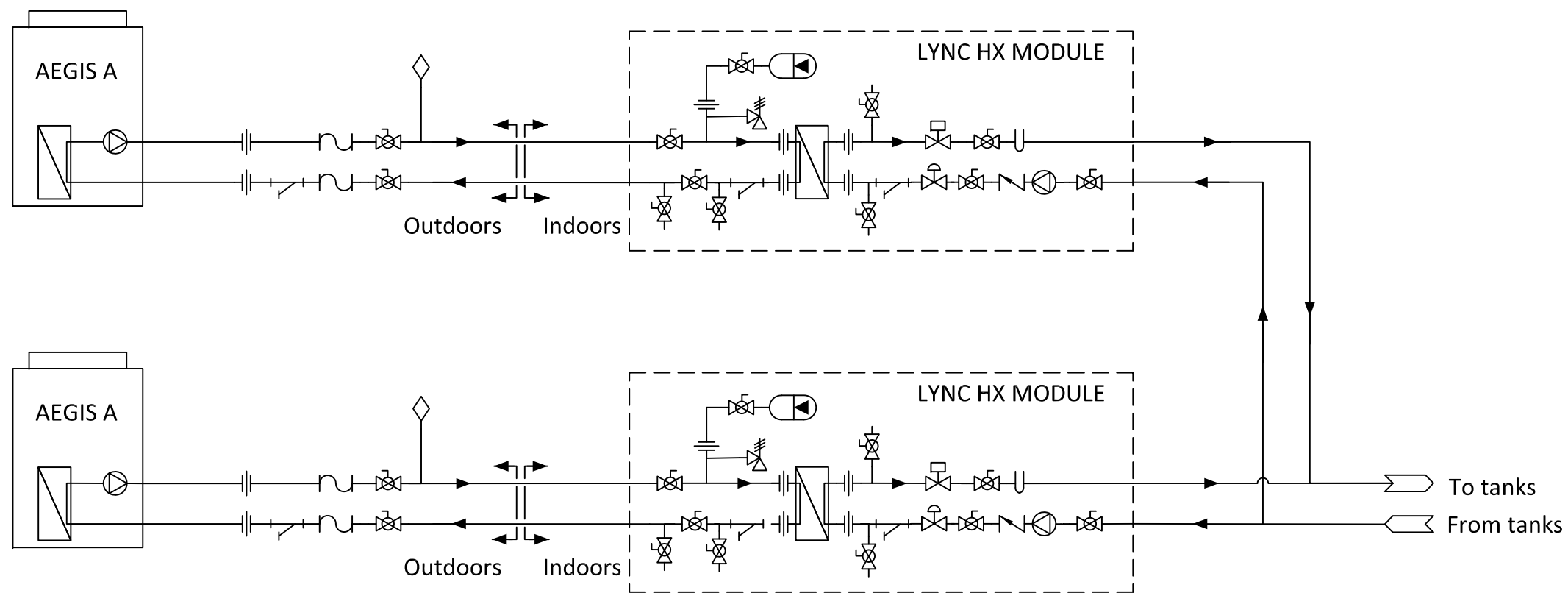

### NOTES:

- 1) NOT FOR CONSTRUCTION.
- 2) FINAL HEAT EXCHANGER MODULE DESIGN SUBJECT TO CHANGE.
- 3) PIPE FLOW VELOCITY NOT TO EXCEED 2 ft./sec.  
BIN 1/2 AEGIS UNITS WITH HEAT EXCHANGER MODULE MARK I.
- 4) HEAT EXCHANGER MODULE MARK I CONNECTIONS ARE 1-1/2" NPT.

	Blauvelt, NY Fort Worth, TX	
<b>AEGIS A 2 UNITS INSTALLATION</b>		
DWN.BY <u>K.S.</u> DATE <u>090622</u> SCALE <u>NTS</u> APPD. _____ DATE _____	<b>SD-L-1252</b>	REV. A